

User Manual

DA16200 SPI Sflash Downloader

UM-WI-012

Abstract

This User Manual explains how to setup and use the DA16200 SPI Serial flash Downloader.

DA16200 SPI Sflash Downloader

Contents

Abstract 1

Contents 2

Figures..... 2

Tables 2

1 Terms and Definitions..... 3

2 References 3

3 Prepare 4

 3.1 DA16200 Images 4

 3.2 Setup PC Environment..... 4

 3.3 Setup Pin Configuration for SPI Slave 4

 3.4 Setup Register Value of SPI Slave 6

4 CLI program for SPI Interface 7

 4.1 Setup Pin Mux Binary File..... 7

 4.2 Check SPI Connection..... 7

5 Run SPI Sflash Downloader 8

 5.1 Setup and Select Images 9

 5.2 Link to PC..... 10

 5.3 Download Images 10

 5.4 Unlink from PC 11

Revision History 12

Figures

Figure 1: DA16200 EVK Board Version 7 5

Figure 2: Setup Switch for SPI Slave 5

Figure 3: Setup Register Value for SPI Slave 6

Figure 4: Configuration for GUI 7

Figure 5: Read DA16200 Chip ID..... 8

Figure 6: SPI Sflash Downloader 8

Figure 7: Setup and Select Image..... 9

Figure 8: Link to PC..... 10

Figure 9: Download Images..... 11

Tables

Table 1: Pin Multiplexing for SPI Slave 4

Table 2: Pin Configuration for SPI Slave..... 5

Table 3: Register value for SPI slave 6

Table 4: Pin Mux Binary Files..... 7

DA16200 SPI Sflash Downloader

1 Terms and Definitions

DPM	Dynamic Power Management
GUI	Graphical User Interface
SPI	Serial Peripheral Interface
SFDP	Serial Flash Discoverable Parameter
UART	Universal Asynchronous Receiver Transmitter

2 References

- [1] DA16200, Datasheet, Dialog Semiconductor
- [2] DA16200, SDK Programmer Guide, Dialog Semiconductor
- [3] DA16200, EVK User Manual, Dialog Semiconductor
- [4] DA16200, AT Command User Manual, Dialog Semiconductor

DA16200 SPI Sflash Downloader

3 Prepare

The SPI Sflash downloader tool serves to download the images to SFLASH via an SPI slave interface. For the USB to SPI interface, the FT2232H module needs to be used. There are 3 prepare steps needed to use the SPI Sflash downloader tool.

- The first is to set pin configuration for the SPI slave interface. See section 3.3 and 3.4
- The second is to connect the SPI slave interface with the FT2232H module. See chapter 4
- The third is to download the DA16200 images with the SPI Sflash downloader tool. See section 5

3.1 DA16200 Images

There are three types of images needed to operate the DA16200:

- Bootloader: This image has the important Serial Flash type information
- RTOS: This image contains Wi-Fi libraries and system/user applications
- SLIB: This image includes system libraries such as RF drivers and libraries for DPM operation

3.2 Setup PC Environment

The DA16200 EVK supports the use of a USB port. Use a micro-USB cable to connect the test PC with the EVK. Two COM ports will be detected automatically.

Please install the FT2232 Driver for windows. In most cases, the driver will be installed automatically. If not installed automatically, use the following URL to download and install the driver: http://www.ftdichip.com/Drivers/CDM/CDM21224_Setup.zip.

3.3 Setup Pin Configuration for SPI Slave

The DA16200 SoC has two SPI Slave ports with a GPIO pin mux setting, which are GPIOA0 ~ GPIOA3 and GPIOA6 ~ GPIOA9. The recommendation is to use GPIOA0 ~ GPIOA3, because the DA16200 EVK uses GPIOA6 ~ GPIOA9 for other functions.

But if there is need to use GPIOA6 ~ GPIOA9 on the EVK board and the USB driver chipset board, see Table 1 for the SPI slave pin configuration.

Table 1: Pin Multiplexing for SPI Slave

SPI Slave	GPIO set #1 SW3	GPIO set #2 SW1
SPI_MISO	GPIOA0	GPIOA8
SPI_MOSI	GPIOA1	GPIOA9
SPI_CS	GPIOA2	GPIOA6
SPI_CLK	GPIOA3	GPIOA7

DA16200 SPI Sflash Downloader



Figure 1: DA16200 EVK Board Version 7

To use GPIOA0 ~ GPIOA3 for the SPI Slave interface, all switches of SW3 on the EVK board should be changed to the **On** state. See [Table 2](#) and [Figure 2](#).

Table 2: Pin Configuration for SPI Slave

SPI Slave	DA16200 Pin	Switch 3	FT2232H-56Q
SPI_MISO	GPIOA0	On	#34 TDO/DI
SPI_MOSI	GPIOA1	On	#33 TDI/DO
SPI_CS	GPIOA2	On	#35 TMS/CS
SPI_CLK	GPIOA3	On	#32 TCK/SK

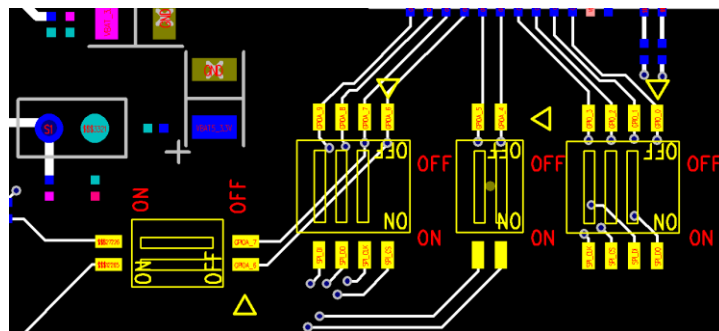
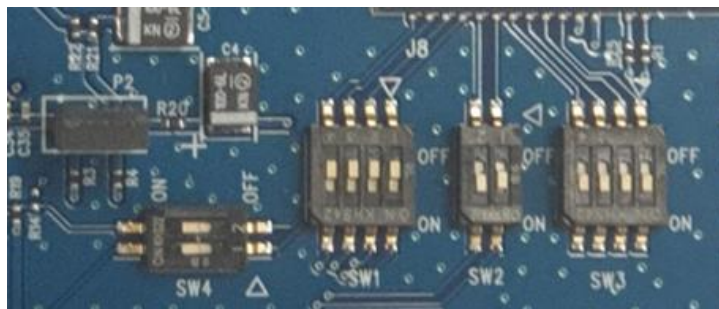

Figure 2: Setup Switch for SPI Slave

DA16200 SPI Sflash Downloader

3.4 Setup Register Value of SPI Slave

For the SPI slave pin configuration, the register value needs to be changed to set the switch on the board.

1. Type `reset` command to change the `[/DA16200]` prompt to `[MROM]` prompt. See [Figure 3](#).
2. Type command `lrd 50001208` to read the current pin configuration.
3. Use command `lwr 50001208 3f699311` to write the pin configuration for the SPI slave (GPIOA0 ~ GPIOA3).
4. Type command `lrd 50001208` to read the changed Pin configuration.

Command `lrd` means 'long read data'. Command `lwr` means 'long write data' and these commands read and write per 4 bytes. The recommendation is to close the serial window after the register value is set.

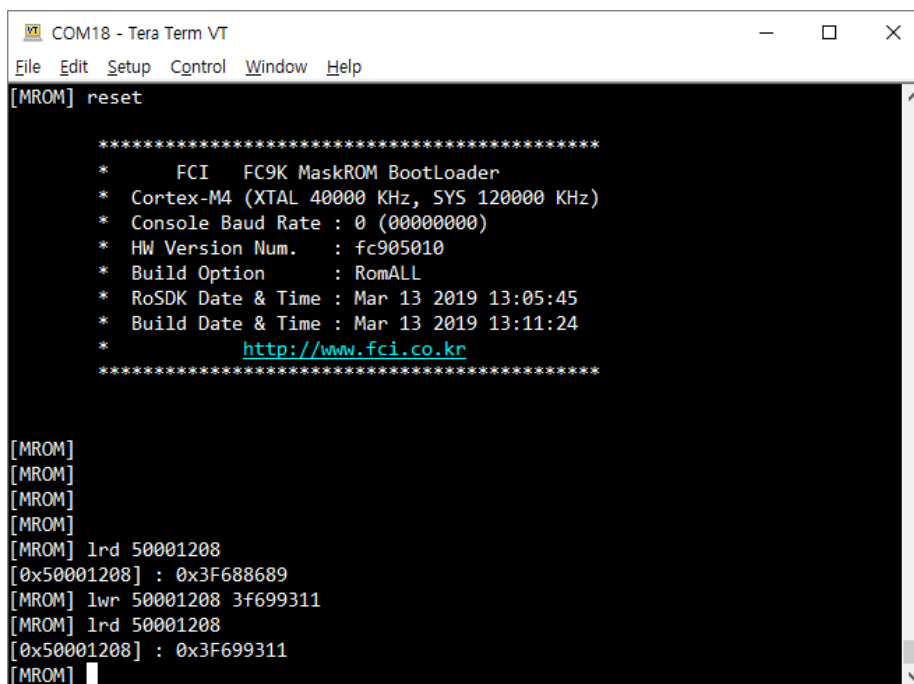

```

COM18 - Tera Term VT
File Edit Setup Control Window Help
[MROM] reset

*****
*   FCI   FC9K MaskROM BootLoader
* Cortex-M4 (XTAL 40000 KHz, SYS 120000 KHz)
* Console Baud Rate : 0 (00000000)
* HW Version Num.   : fc905010
* Build Option      : RomALL
* RoSDK Date & Time : Mar 13 2019 13:05:45
* Build Date & Time : Mar 13 2019 13:11:24
*                  : http://www.fci.co.kr
*****

[MROM]
[MROM]
[MROM]
[MROM]
[MROM] lrd 50001208
[0x50001208] : 0x3F688689
[MROM] lwr 50001208 3f699311
[MROM] lrd 50001208
[0x50001208] : 0x3F699311
[MROM]
    
```

Figure 3: Setup Register Value for SPI Slave

Table 3: Register value for SPI slave

Address: [0x50001208]	Default Value: 0x3F688689
GPIOA0 ~ GPIOA3	0x3F699311
GPIOA6 ~ GPIOA9	0x3F611689

DA16200 SPI Sflash Downloader

4 CLI program for SPI Interface

The CLI program (`wifi_usb2spi_flash_dn.exe`) checks the SPI interface connection between the DA16200 EVK and the FT2232H module. [Figure 4](#) shows a list of files for the SPI Sflash downloader.

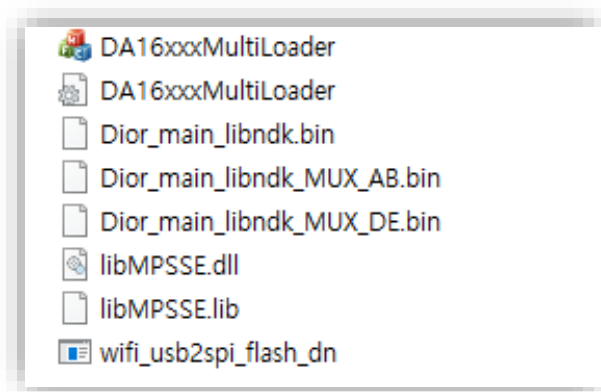

Figure 4: Configuration for GUI

4.1 Setup Pin Mux Binary File

The binary file for `wifi_usb2spi_flash_dn.exe` is `Dior_main_libndk.bin`. For the correct SPI slave setup, the binary file name `Dior_main_libndk_MUX_AB.bin` or `Dior_main_libndk_MUX_DE.bin` may need to be changed depending on pin configuration of SPI slave interface.

For example, to change the binary file :

Rename `Dior_main_libndk_MUX_AB.bin` to `Dior_main_libndk.bin`.

The default binary file (`Dior_main_libndk.bin`) is set to use GPIOA0 ~ GPIOA3, so in that case there is no need to change the binary file name. See [Table 4](#).

Table 4: Pin Mux Binary Files

Default Binary File	Dior_main_libndk.bin
GPIOA0 ~ GPIOA3	Dior_main_libndk_MUX_AB.bin
GPIOA6 ~ GPIOA9	Dior_main_libndk_MUX_DE.bin

4.2 Check SPI Connection

To check if the SPI connection is successful or failed, read the DA16200 chip ID address of 50080200. See [Figure 5](#). It is a success if the chip ID is 0XFC905001 in CLI program. But if the SPI connect failed, then check the installation of the FT2232H driver on the test PC.

DA16200 SPI Sflash Downloader

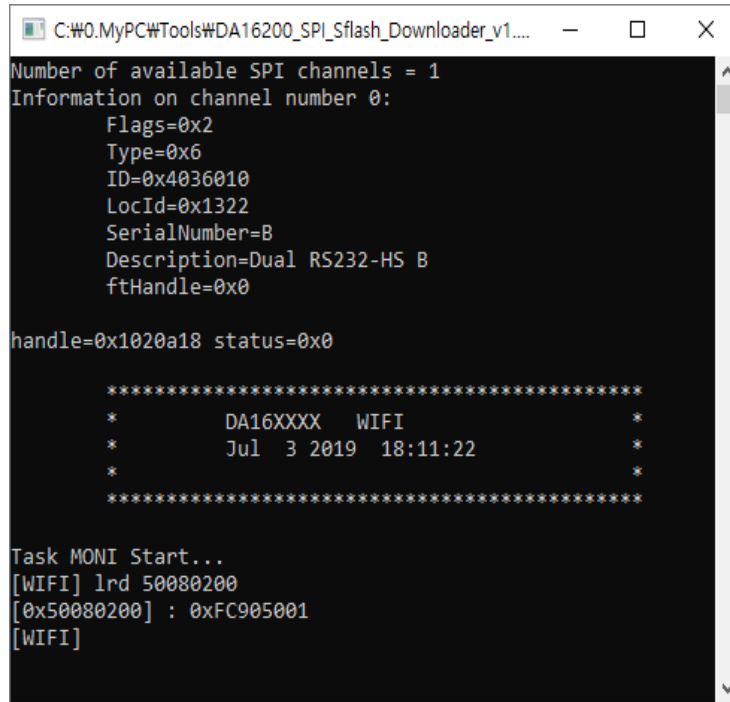

Figure 5: Read DA16200 Chip ID

5 Run SPI Sflash Downloader

Figure 6 shows the SPI Sflash downloader tool (DA16xxxMultiLoader.exe). The Terminals show the number of USBs connected to the SPI interface. The Multi-Downloader GUI can directly control the FT2232H modules. After the CLI program (wifi_usb2spi_flash_dn.exe) is closed, start the SPI Sflash downloader tool to avoid any collisions.

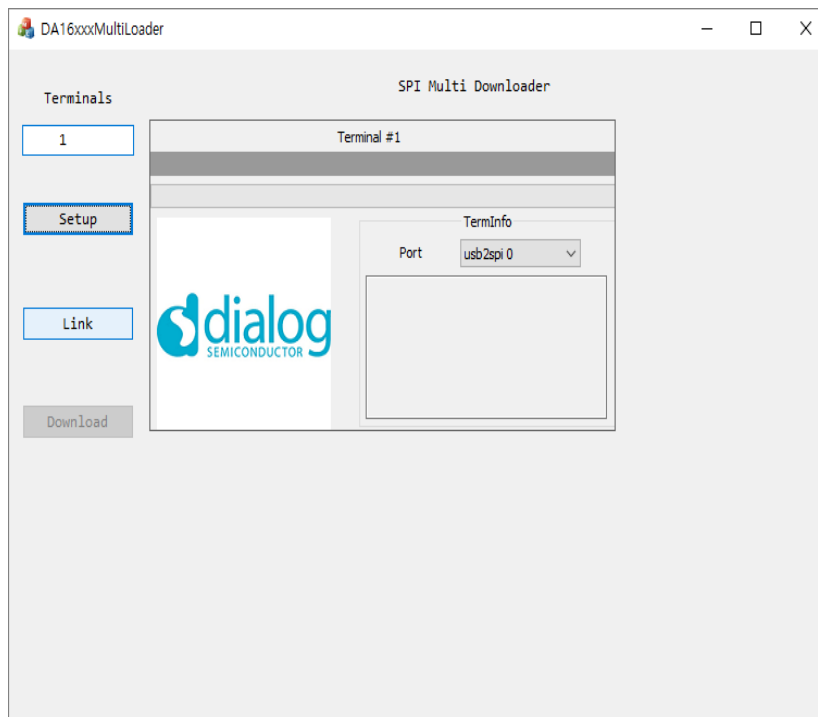

Figure 6: SPI Sflash Downloader

DA16200 SPI Sflash Downloader

5.1 Setup and Select Images

1. Click the Setup button to setup and select images.
 - [Figure 7](#) shows the Setup window to select image files to download
2. Click on a blank button to select the files.
 - BOOT: Select the Bootloader image that starts with DA16200_BOOT
 - RTOS: Select the Main RTOS image that starts with DA16200_RTOS
 - SLIB: Select the System Library image that starts with DA16200_SLIB
 - MAP: Select serial flash memory size
3. After the file is selected, click **OK** to apply the changes. See [Figure 7](#).



Figure 7: Setup and Select Image

DA16200 SPI Sflash Downloader

5.2 Link to PC

1. Click the **Link** button to setup a link between the test PC and the DA16200 via the SPI interface. The status changes as shown in [Figure 8](#).

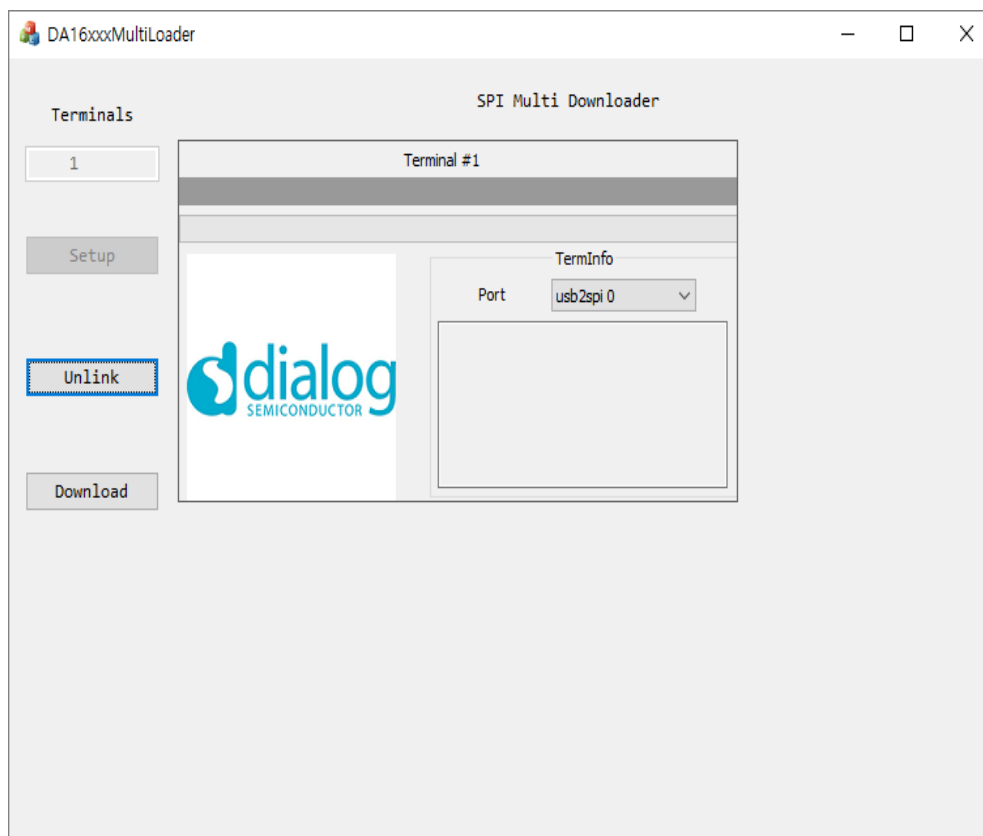

Figure 8: Link to PC

5.3 Download Images

1. Click the **Download** button to start the download of DA16200 images. When the status progress bar goes all the way, all downloads are complete.

DA16200 SPI Sflash Downloader

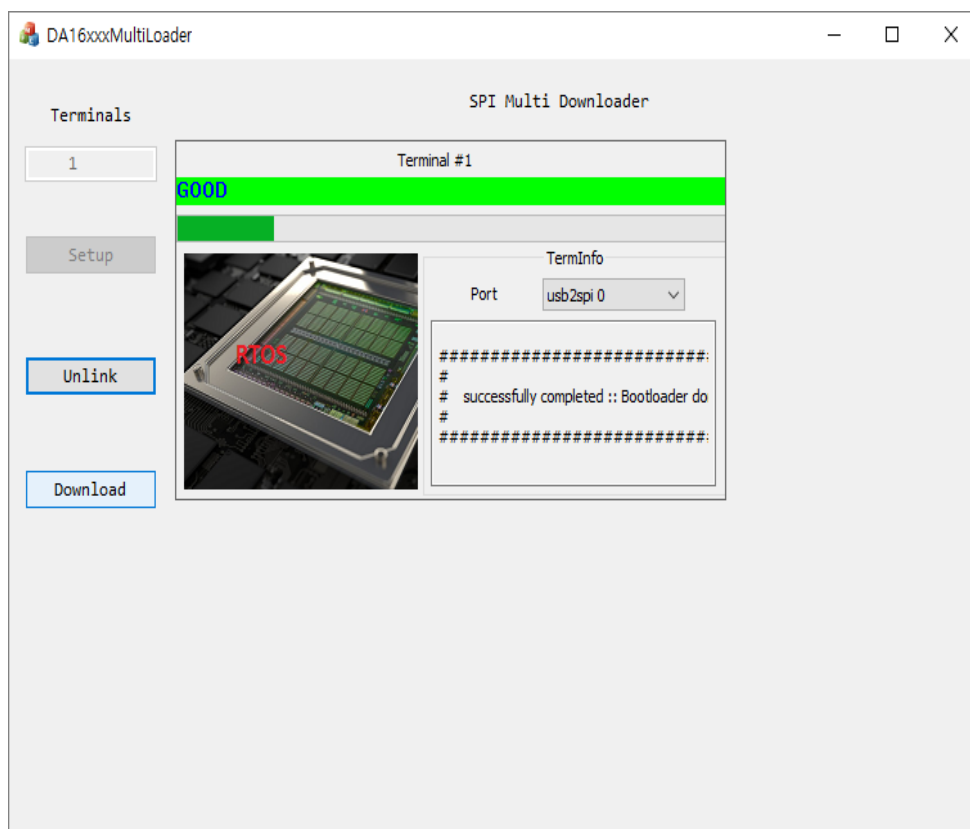

Figure 9: Download Images

5.4 Unlink from PC

1. Click the **Unlink** button to reset and boot the DA16200 with the new image. After the Unlink operation is done, the SPI connection depends on the new boot image.

DA16200 SPI Sflash Downloader**Revision History**

Revision	Date	Description
1.5	26-Jun-2020	Update contents and figures for EVK board v7.0 in section 3.3
1.4	26-Nov-2019	Finalized for publication
1.3	19-Nov-2019	Editorial review
1.2	02-Aug-2019	Update the selection of Sflash size in section 5.1
1.1	24-Jul-2019	Update pin configuration in section 3.3 Update CLI program for SPI interface in chapter 4
1.0	05-Jul-2019	Preliminary draft release

DA16200 SPI Sflash Downloader

Status Definitions

Status	Definition
DRAFT	The content of this document is under review and subject to formal approval, which may result in modifications or additions.
APPROVED or unmarked	The content of this document has been approved for publication.

Disclaimer

Unless otherwise agreed in writing, the Dialog Semiconductor products (and any associated software) referred to in this document are not designed, authorized or warranted to be suitable for use in life support, life-critical or safety-critical systems or equipment, nor in applications where failure or malfunction of a Dialog Semiconductor product (or associated software) can reasonably be expected to result in personal injury, death or severe property or environmental damage. Dialog Semiconductor and its suppliers accept no liability for inclusion and/or use of Dialog Semiconductor products (and any associated software) in such equipment or applications and therefore such inclusion and/or use is at the customer's own risk.

Information in this document is believed to be accurate and reliable. However, Dialog Semiconductor does not give any representations or warranties, express or implied, as to the accuracy or completeness of such information. Dialog Semiconductor furthermore takes no responsibility whatsoever for the content in this document if provided by any information source outside of Dialog Semiconductor.

Dialog Semiconductor reserves the right to change without notice the information published in this document, including, without limitation, the specification and the design of the related semiconductor products, software and applications. Notwithstanding the foregoing, for any automotive grade version of the device, Dialog Semiconductor reserves the right to change the information published in this document, including, without limitation, the specification and the design of the related semiconductor products, software and applications, in accordance with its standard automotive change notification process.

Applications, software, and semiconductor products described in this document are for illustrative purposes only. Dialog Semiconductor makes no representation or warranty that such applications, software and semiconductor products will be suitable for the specified use without further testing or modification. Unless otherwise agreed in writing, such testing or modification is the sole responsibility of the customer and Dialog Semiconductor excludes all liability in this respect.

Nothing in this document may be construed as a license for customer to use the Dialog Semiconductor products, software and applications referred to in this document. Such license must be separately sought by customer with Dialog Semiconductor.

All use of Dialog Semiconductor products, software and applications referred to in this document is subject to Dialog Semiconductor's [Standard Terms and Conditions of Sale](http://www.dialog-semiconductor.com), available on the company website (www.dialog-semiconductor.com) unless otherwise stated.

Dialog, Dialog Semiconductor and the Dialog logo are trademarks of Dialog Semiconductor Plc or its subsidiaries. All other product or service names and marks are the property of their respective owners.

© 2020 Dialog Semiconductor. All rights reserved.

Contacting Dialog Semiconductor

United Kingdom (Headquarters)

Dialog Semiconductor (UK) LTD
Phone: +44 1793 757700

Germany

Dialog Semiconductor GmbH
Phone: +49 7021 805-0

The Netherlands

Dialog Semiconductor B.V.
Phone: +31 73 640 8822

Email:

enquiry@diasemi.com

North America

Dialog Semiconductor Inc.
Phone: +1 408 845 8500

Japan

Dialog Semiconductor K. K.
Phone: +81 3 5769 5100

Taiwan

Dialog Semiconductor Taiwan
Phone: +886 281 786 222

Web site:

www.dialog-semiconductor.com

Hong Kong

Dialog Semiconductor Hong Kong
Phone: +852 2607 4271

Korea

Dialog Semiconductor Korea
Phone: +82 2 3469 8200

China (Shenzhen)

Dialog Semiconductor China
Phone: +86 755 2981 3669

China (Shanghai)

Dialog Semiconductor China
Phone: +86 21 5424 9058